

Composite dry sliding bushings, metric dimensions

Principal dimensions			Basic load ratings		Mass	Designation
d	D	B	dynamic C	static C0	kg	-
mm	55	40	kN			
50	55	40	156	490	0,13	PCM 505540 E

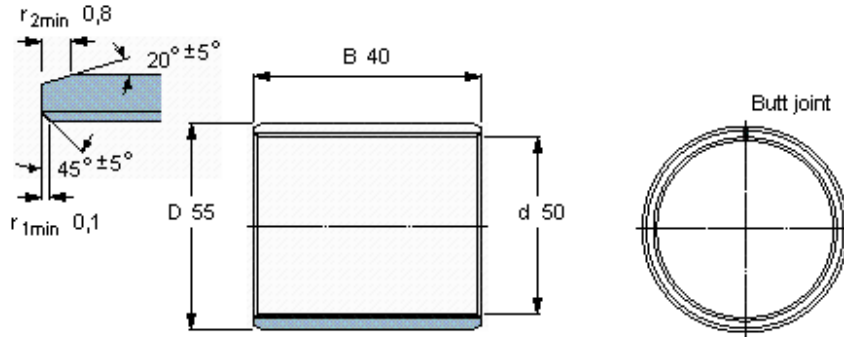

Specific load factor K 80
Material constant K_M 480